



Pump specifications:

Type.....	PT150 D155
Design.....	Direct Drive Design®
Max. flow	58 m ³ /hour (250 US GPM)
Max. pressure	20 mwc (66 ft.)
Max. suction lift.....	9.6 mwc (32 ft.)
Diesel engine	Hatz 1D90V DriveOn®
Emission standard	Stage V
Fuel consumption	Max. 1.1 L/hour
Canopy	L10-23
Connections.....	4" or 6"
Sound level.....	Approx. 48 dB(A) at 10 m
Dry weight.....	1575 kg (3465 lbs.)

FEATURES

PT Wellpoint pump

The PT wellpoint pump has been designed for vertical- and horizontal dewatering applications. These positive displacement pumps are fully self-priming and are capable of handling air, water or any mixture of both without requiring a separate priming system. Furthermore, these pumps are capable of running dry indefinitely without causing damage or excessive wear to any part of the unit.

World-class performance

The PT pump package offers lowest cost of ownership and provides a reliable and durable solution to the challenges facing dewatering companies around the world. The technology has been tried and tested in the field and has revolutionised the vertical- and horizontal dewatering market on a global scale, by offering unmatched performance at minimal costs thereby improving the return on investment (ROI).

Key features PT Pumps

- Self-priming, no additional priming system required
- Excellent suction capabilities on all flows
- High pump efficiency
- Can run dry indefinitely
- Cheap and easy-to-replace wear parts
- 100% mechanical technology
- Extended unit life time
- Ergonomic design

Complete package designed & built by BBA Pumps

- Complete in-house design & production
- Over 60 years of experience in the market
- Extensive testing facility in-house
- Contemporary & functional design
- Durable & eco-friendly materials

After sales service & product support

- Single supplier for parts, spares & accessories
- Dedicated customer help-desk (24h service)
- Dedicated service department in-house
- Global parts distribution network
- Optional global on-site servicing
- Extensive training options available (technical & commercial), on-site or in-house



STANDARD TECHNICAL SPECIFICATIONS

BBA double acting, duplex piston pump

Pump type.....	PT150 D155
Max. flow.....	58 m ³ /hour (250 US GPM)
Max. head.....	20 mwc (66 ft.)
Max. suction lift.....	9.6 mwc (32 ft.)
Speed (factory standard)	64 strokes/min
Pump casing.....	Cast iron GG20
Valve cover.....	Aluminium
Cylinder liners.....	Stainless steel Ø 150 mm
Piston cups.....	Leather
Piston rods.....	Stainless steel 304
Shaft seal.....	Gland packing
Valve rubbers.....	Stainless steel core with rubber layer
Valve seats.....	Composite (optionally available in bronze)
Drive.....	Direct Drive Design®
Measure equipment.....	2 vacuum gauges



Engine

Engine brand.....	Hatz
Engine type.....	1D90V
Power.....	6.1 kW (8.3 Hp)
Max. engine speed.....	1500 RPM
Feature.....	DriveOn®
Oil change interval.....	1500 running hours
Fuel consumption.....	233 g/kWh
Displacement.....	0.722 l (44 cu.in.)
Number of cylinders.....	1
Cooling system.....	Air cooled
Starting method.....	Electric start & stop
Oil sump.....	10 ltr.(2.63 US Gallon)
Emission level.....	Stage V



DriveOn®

BBA Dashboard LC10

- Composite dashboard
- Hour counter
- Key start switch
- Warning light "oil pressure"
- Warning light "alternator"

Fuel system

- Composite fuel tank 200 L (54 US Gallon)
- Fuel tank cap Ø 100 mm (4 inch)
- Mechanical fuel injection system
- Fitted with water separator & extra in-line fuel filter

Electrical system & safety features

- Nominal voltage 12 Volt
- Premium quality battery
- Low oil pressure shut down

CANOPY L10-23

BBA super silent canopy

- Canopy type.....L10-23
- Dimensions L x W x H 2300 x 1050 x 1425 mm
- Dimensions L x W x H 90 x 41.3 x 56 inch
- Basic frame Hot dip galvanized
- Roof panels..... Composite ABS/ASA
- Doors 4 easy-access doors (lockable)
- Grill and door panels Composite ABS/ASA
- Fuel tank PE net 200 ltr (54 US Gallon)
- Fuel tank autonomy 180 - 330 hours (according to load)
- Fuel tank cap 100 mm (4 inch)
- Lifting point Fitted with single lifting point
- Stackable Canopy is stackable
- Connections..... Please consult "auxiliary items"
- Exhaust system Fully integrated in the canopy
- Documentation box..... BBA user manual and warranty book

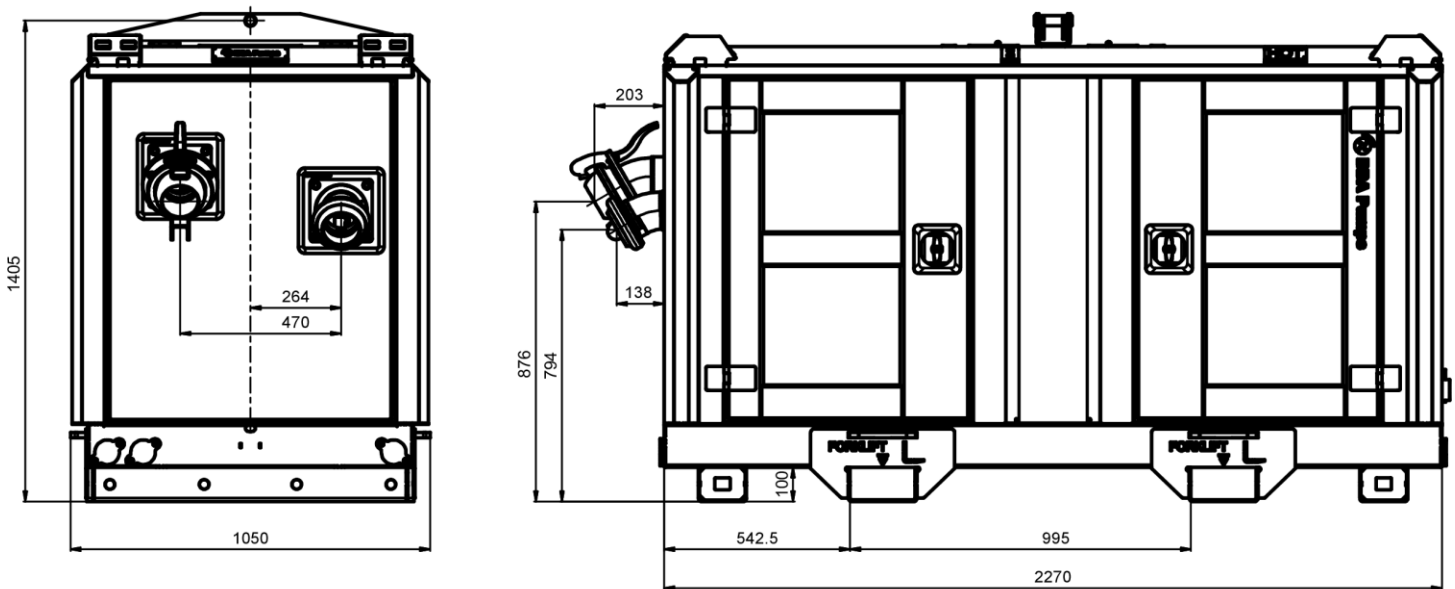

Actual dimensions (in mm) may vary depending on selected quick couplings.

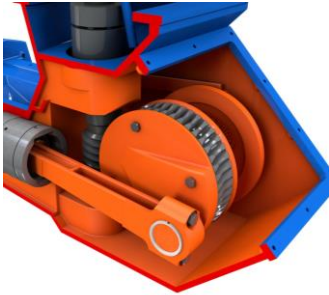

Direct Drive Design®
Precisely machined drive gears and an automatic lubrication system provide excellent efficiency and minimal sound emissions.



Hatz DriveOn®
-Large oil sump
-Service interval 1500 hours
-25% saving on engine oil
-Ergonomic design

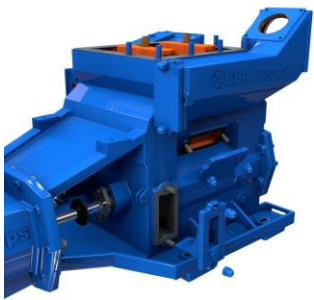

Easy access points
Allows access to the cylinders, valves, stuffing boxes and other critical areas for easy cleaning and maintenance.

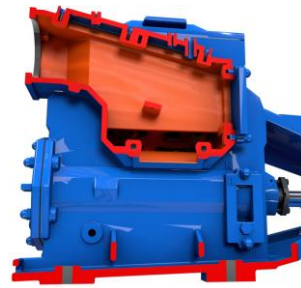

Integrated stone catcher
To protect the pump internals from any suspended solids. The stone catcher has 3 inspection covers and comes with dual vacuum gauges to monitor pump performance.

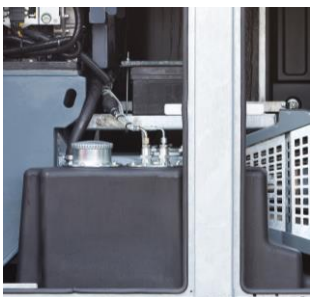

Fuel tank
Fully bunded, corrosion-free, 200 litre, high-density polyethylene fuel tank, located in base of canopy.

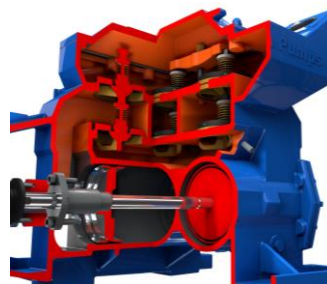

Excellent pump hydraulics
A patented suction valve seat and improved hydraulics guarantee the best pump efficiency and unbeatable vacuum build up.



4 Year limited warranty
The BBA limited warranty covers years or operating hours whichever occurs first. For more details please consult the BBA warranty book.



User Manual PT series
Extensive user manual with important information concerning the pump unit, pump installation and safety warnings. Available in several languages.

AUXILIARY ITEMS (configurable)

Discharge and suction connections

Art.nr.		Ø inch	Ø mm	Connection	
3111410	30° male (ball)	4	100	System C	
3111411	30° female (cup)	4	100	System B	
3111412	30° male (ball/lever)	4	100	System B	
5080877	30° male (ball)	6	150	System C	
5080876	30° female (cup)	6	150	System B	
5080881	30° male (ball/lever)	6	150	System B	

Fuel gauge

9306000070	<p>Mechanical fuel gauge on tank The standard 100 mm fuel filler cap will be replaced by a small 60 mm fuel filler cap and put together with the fuel gauge.</p>	
------------	---	--

Roof panel for easy access

	<p>Hinged roof panel The light weight standard composite roof panel can be replaced by a hinged steel roof panel (hot dip galvanized).</p>	
--	---	---

Exhaust system

	<p>Exhaust module prepared for DPF/DOC Ready for the future with the unique BBA Pumps exhaust module. Standard fitted with a certified spark arrestor and fully prepared for installation of a diesel particulate filter & oxidation catalyst.</p>	
--	---	---

Environmental care

9306000110	<p>Diesel Particulate Filter & Oxidation Catalyst</p> <ul style="list-style-type: none"> - Fully integrated in the exhaust module - Reduction of Particulate Matter, PM > 95% - Reduction of Hydrocarbon, HC > 50% maximum 65% - Reduction of Carbon Monoxide, CO > 70% maximum 90% - VERT® Certified 	
------------	--	---